



NVS200USAS Duplicator

User Manual
v A.01



Index Table

Product Disclaimer	2
Warranty.....	2
Piracy Statement.....	2
Before You Start.....	3
Notice Symbols	3
Product Overview	4
Functions Table.....	6
Functions Description	9
1. Copy	9
2. Compare.....	9
3. Copy+Compare	9
4. Erase.....	10
5. Utility	11
6. Setup.....	12
Maintenance Guide	19

Product Disclaimer

U-Reach is not accountable for any incidental or consequential damages, which includes, but is not constrained to property harm, loss of time or data from use of a U-Reach product, or any other damages attributable to product malfunction or failure (including without limitation, those attributable to: (1) reliance of the materials provided, (2) costs of product replacement, (3) loss of use, data or profits, (4) delays or business interruptions, (5) and any principle of legal responsibility, arising out of or in reference to the use or overall performance or from delays in servicing or lack of ability to render service) of any U-Reach product. U-Reach makes every effort to ensure proper operation of all products. However, the customer is responsible to affirm that out of the U-Reach product meets the customer's quality requirement. The customer further acknowledges that fallacious operation of U-Reach product and/or software program, or hardware issues, can cause loss of data, defective formatting, or data loading. U-Reach will make efforts to resolve or repair any issues recognized by customer either within the warranty period or on a time and materials basis.

Specifications and features subject to change without notice or obligation.

Warranty

U-Reach provides a basic one-year parts and labor warranty for all its products (excluding cables, adapters, and other consumable items). An optional extended warranty is also available for an added cost. Telephone and email support is available for the life of the product as defined by U-Reach.

All warranties will be restricted and defined by the market region from which customers purchased.

Piracy Statement

U-Reach accepts no responsibility for copyright infringement or misuse of any U-Reach equipment. Copying all forms of data: audio, video, or software without the permission of the copyright holder is illegal. It is the sole responsibility of the user to ensure that the legal copyrights of the copyright owners are respected.

Before You Start

Important Notice

- Carefully read the entire manual before operating.
- Make sure the source device is correct and functioning.
- Equal capacity of source and target is recommended for guaranteed data consistency.
- Using the Copy+Compare function provides the most flawless duplication.
- Damage incurred due to non-compliance with our operating instructions will void the warranty.
- Store the equipment safely when not in use and keep out of the reach of children.
- Please turn off duplicator before replacing a socket.
- Never turn off the power while the firmware is updating.
- Use only approved, stable power sources.
- The power supply has overload protection. When it is overloaded and shutdown, please unplug the power cord for 2 minutes for discharge.
- Use product only in a clean, dry, dust-free, and ventilated area. Liquids or foreign debris can severely damage your duplicator.
- It is typical for the machine to heat up during operation.
- While in use, do not move the duplicator or remove SSDs.
- Static electricity may cause duplication error. Please pay attention to the duplicator's environment while operating equipment. Purchasing electricity elimination equipment helps avoid shock.
- Devices will operate at high temperatures during selected tasks.
- Wear protective gloves to prevent burns when handling devices.
- Ensure machine and operator are properly grounded to prevent ESD.
- Do not turn off the machine during firmware update.

Notice Symbols

Special items, procedures, or notes to be observed prior to use.

Note

Refers to related duplicator operations, special details, tips, or suggestions for operational effectiveness.

Caution

Refers to procedures that need to be adhered to or precautions.

Product Overview

- Front View

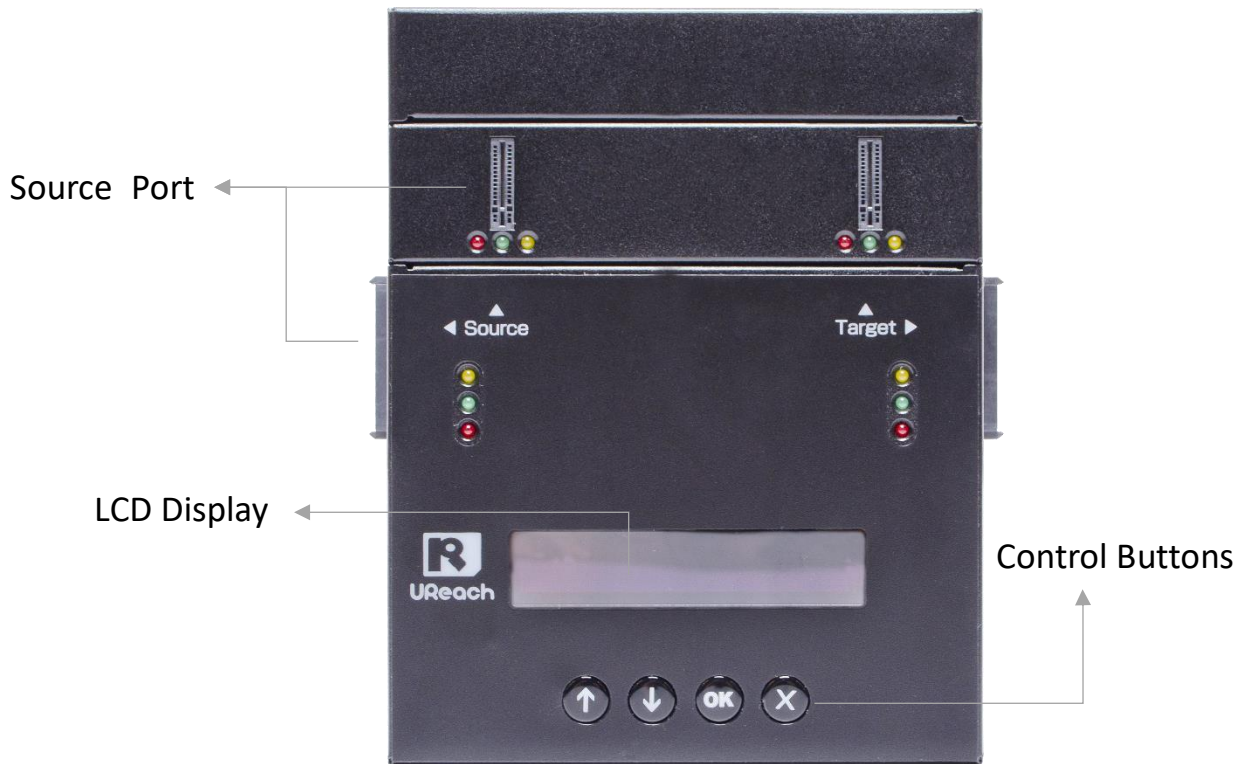

- Back View

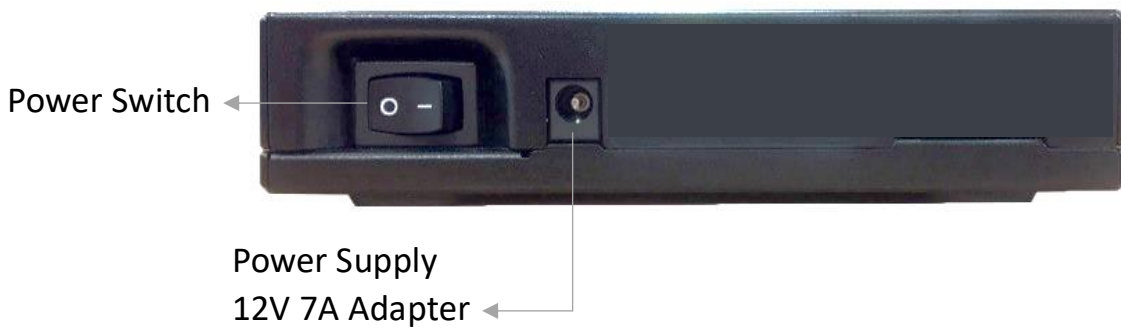

- Package

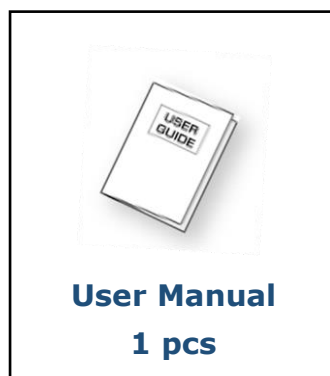
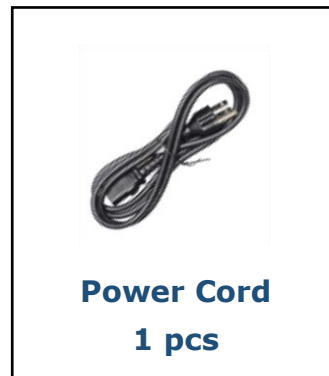

- Optional

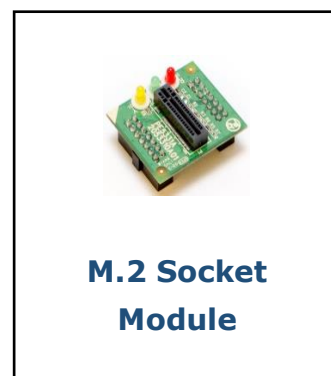

Functions Table

Functions	Descriptions	
1. Copy	Copies data from source device to targets. (There are four copy modes in function "6.1 Copy Mode")	
2. Compare	Compares the source and targets to ensure copy accuracy.	
3. Copy + Compare	Automatically launches compare function after copy is completed.	
4. Erase	4.1 Quick Erase Erases device(s)' index table.	
	4.2 Full Erase Erases entire device(s), complying with NIST 800-88 Standards.	
	4.3 DoD Erase Erases device(s), complying with DoD 5220.22-M Standards.	
	4.4 DoD EraseComp Erases device(s), complying with DoD 5220.22-M Standards and verifies complete erasure.	
	4.5 7-Pass Erase Erases device(s) 7 times complying with DoD 5220.22-M(ECE) Standards.	
	4.6 Secure Erase Erases the non-loadable areas complying with NIST 800-88 Standards.	
	4.7 Enhanced Secure Erase Erases devices that support this feature.	
5. Utility	5.1 Show Device Info Displays basic information such as device model, name, capacity, etc.	
	5.2 Update System	5.2.1 Update BIOS Updates system firmware through the rear SD port or the source port.
		5.2.2 Create BIOS Format Prepares by formatting the device to a 2GB FAT partition to accept firmware file.
	5.3 System Info Displays system information such as controller, model number, software version, etc.	
	5.4 Read Speed Calculate the device's read speed by reading.	
5.5 Write Speed Calculate the device's write speed by reading. This function will change the device's content and format.		

	5.6 Calc. CRC64 Calculate the CRC64 value of the source device.		
6. Setup	6.1 Copy Mode	System and Files Copies data and skips empty space. Only supports standard formats.	
		All Partitions Copies all partitions and data, unallocated partitions not included.	
		Whole Device Copies all source data, bit-by-bit.	
		Percentage (%) Sets percentage of source capacity to copy.	
	6.2 Copy GPT Backup Area Disable this function to copy the GPT backup area.		
	6.3 HPA Copy Mode	Do Not Copy HPA	Keep Target HPA Does not copy HPA data but keeps target device's original HPA setting.
			Clear Target HPA Does not copy HPA data and clears target device's HPA setting.
		Setting Target HPA Copies HPA setting from source device to target.	
		Copy and Setting Copies HPA setting and data from source device to target.	
	6.4 Skip Bad Sectors Skips source bad sectors.		
	6.5 Erase Source Port Allows user to erase the source port or not.		
	6.6 Unknown Format Allows user to copy or skip unknown format(s).		
	6.7 Erase Pattern Sets whether to overwrite data in one-byte or Big random data.		
	6.8 Clear HPA at ERASE	Clear HPA Setting Clears HPA setting during erase.	
Keep HPA Setting Keeps original HPA setting during erase.			
6.9 Language Sets preferred language.			

	<p>6.10 Target Tolerance Sets the capacity tolerance range between the source and target. The default setting is “No limit”.</p>	
	<p>6.11 Clean SSD Before Copy</p>	<p>No The default setting is “No”.</p>
		<p>Yes</p>
	<p>6.12 Restore Defaults Reinstates manufacturer settings.</p>	

Functions Description

1. Copy

Step 1: Prepare source and target devices.

Note

1. Recommendation: Target device(s)' capacity must be equal to or larger than the source device capacity.
2. The system accepts only one source and one target for each operation. If both M.2 and U.2 port have device, it will detect U.2 port first.

Step 2: Connect source and target devices.

Step 3: Proceed to copy.

Scroll to select "1. Copy", then press "OK" to start the duplication process.

The following information below states what is displayed on the LCD during duplication.

Function	←	Copy	40G	→	Total Data
Copied Time & %	←	1:38 25%	10.3G	→	Copied Data

Caution

- Press "ESC" for 5 seconds to stop the copy job.
- It is recommended to reboot the machine after manually stopping the copy.

Step 4: Copy Completed!

The quantity of passed or failed target device(s), the copied duration, and CRC64 will be displayed on the LCD after duplication completes.

2. Compare

Scroll to select "2. Compare", then press "OK" to start the verification process.

3. Copy+Compare

Sequentially automates from Function 1, Copy to Function 2, Compare.

Scroll to select "3. Copy+Compare", then press "OK" to start the automated duplication and verification process.

4. Erase

Caution Please back up all important data before using this function.

Step 1: Connect device(s) for sanitizing.

Step 2: Enter function "4. Erase"

Scroll to select "4. Erase", then press "OK" to view the submenus.

Caution User is responsible for verification of targets' quality. Testing a few completed targets in a mass production environment for quality control is recommended.

4.1 Quick Erase

This function will erase the index table from the connected device(s).
Scroll to select "Quick Erase", then press "OK" to start the erasing process.

4.2 Full Erase

This function will erase all data per NIST 800-88 Standards on the connected device(s).
Scroll to select "Full Erase", then press "OK" to start the erasing process.

4.3 DoD Erase

This function will erase all data per DoD 5220.22-M Standards on the connected device(s).
Scroll to select "DoD Erase", then press "OK" to start the erasing process.

4.4 DoD EraseComp

This function will erase all data per DoD 5220.22-M Standards, then verifies erasure of the connected device(s).
Scroll to select "DoD EraseComp", then press "OK" to start the erasing and verification process.

4.5 7-Pass Erase

This function will erase device(s) 7 times complying with DoD 5220.22-M(ECE) Standards.
Scroll to select "7-Pass Erase", then press "OK" to start the erasing process.

4.6 Secure Erase

This function erases the non-loadable areas complying with NIST 800-88 Standards. Scroll to select "Secure Erase ", then press "OK" to start the erasing process.

4.7 Enhanced Secure Erase

This function erases devices that supports this feature.

Scroll to select "Enhanced Secure Erase", then press "OK" to start the erasing process.

Note

Although Secure Erase/ Enhanced Secure Erase is a command of the SATA-specification, not all SATA devices can support it. When a device that cannot be supported is encountered, the LCD will display Not Support!

5. Utility

This menu will reveal submenus related to device information, system information and updates.

Scroll to "5. Utility", then press "OK" to view the submenus.

5.1 Show Device Info

This function will display basic information such as device model, name, capacity, etc...

Scroll to select "Show Device Info", then press "OK" to view the connected device(s). Then through to view connected device(s) by port number order.

5.2 Update System

Step 1: Prepare a device for update.

Connect a device to the source port. Scroll to select "Create BIOS Format", then press "OK" to start the format process. This will format the device to a 2GB FAT32 Partition.

Step2: Download Firmware.

Connect this device to PC. Download the latest firmware provided by our technical support, unzip the BIOS firmware, then save it to the root directory in the device.

Note

Ensure that the device does not have any bad sectors.

Step3: Proceed to update firmware.

Connect this device to the source port. Scroll to select "Update BIOS", then press "OK" to start the firmware update process.

Caution

The firmware update process may take longer than 5 minutes. Please do not disrupt power or process during BIOS update. If interrupted, the system will become useless. We will not be held responsible for any damages.

5.3 System Info

This function will display basic information such as device model, name, capacity, etc... Scroll to select "System Info", then press "OK" to view the connected device(s). Then scroll through to view all information.

5.4 Read Speed

This function will calculate the read speed of the selected device. The device's original data will not be modified after checking. Scroll to select "Read Speed", then press "OK" to select the device, and then press "OK" to proceed.

5.5 Write Speed

This function will calculate the write speed of the selected device. The device's original data will be modified after checking. Scroll to select "Write Speed", then press "OK" to select the device, and then press "OK" to proceed.

5.6 Calc. CRC64

This function will count the CRC64 value for the source port. The CRC64 value is an easy way to double check the source data is correct. Scroll to select "Calc. CRC64", and then press "OK" to proceed.

Caution

User is responsible for verification of targets' quality. Testing a few completed targets in a mass production environment for quality control is recommended.

6. Setup

This menu will reveal submenus related to copy area, skip bad sector, and setting language. Scroll to select "6. Utility", then press "OK" to view the submenus.

6.1 Copy Mode

There are 4 submenu modes.

Scroll to select "Copy Mode", then press "OK." Then scroll through to select one of the four copy methods.

- **Selecting the Proper Copy Modes**

Example: There are two defined partitions in a 500GB device. The charts below illustrate what portion would be duplicated.

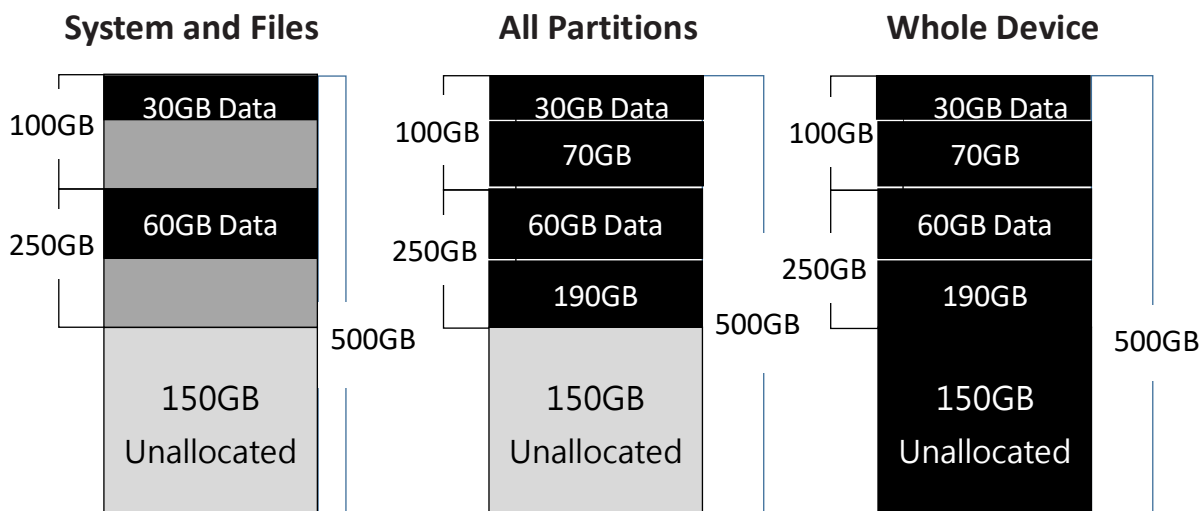

This function will analyze and copy only data and skip empty spaces.

This function will copy all data within the defined partitions.

This function will copy the entire device.

1 System and Files

Copies data and skips empty space. Only supports standard formats.

Scroll to select "System and Files", then press "OK" to save the copy method.

Allows user to copy source device's System and Files, instead of the entire device. The system will analyze the source device and identify the data area to copy. If the source device's data is within the target device's capacity, the copy will be processed. FAT16/32/64, NTFS, EXT2/EXT3/EXT4/lvm, and HFS/HFS+/HFSX are supported in this copy mode.

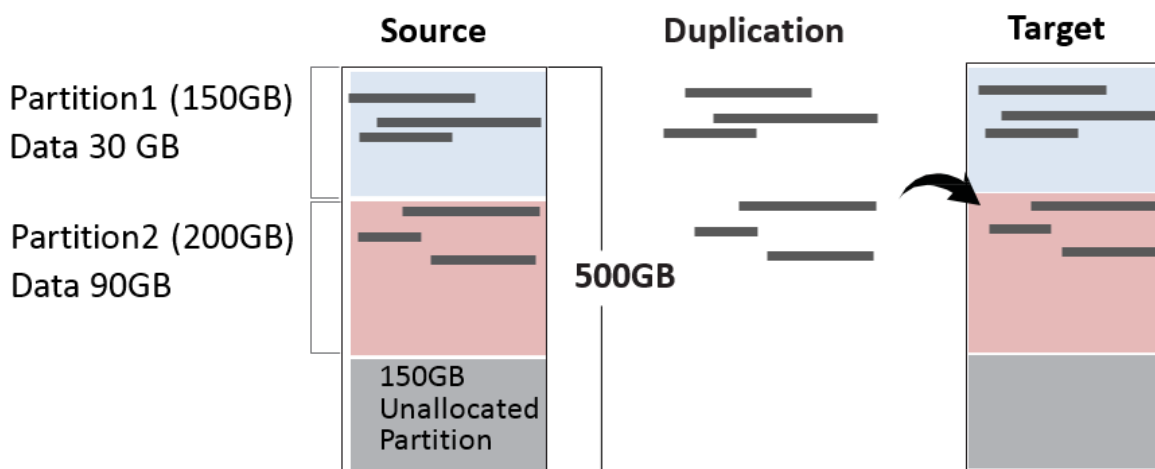

② All Partitions

Copy or skip HPA, DCO, unknown partitions, modified formats, etc. defined by settings. Scroll to select "All Partitions", then press "OK" to save the copy method.

The target device's capacity must be equal to or larger than the source device's capacity.

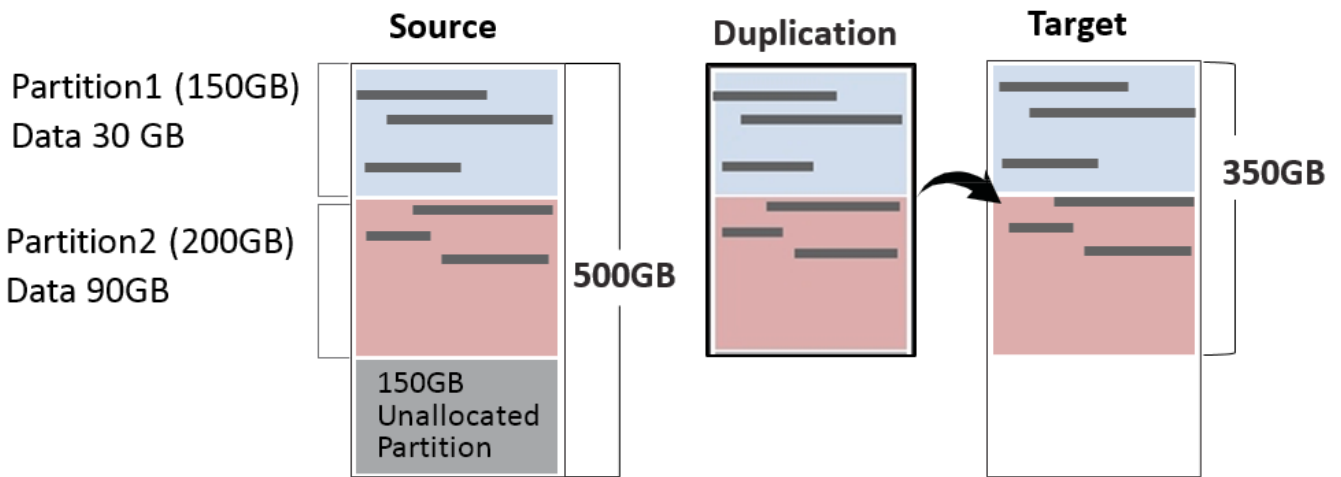

350GB of all Partitions along with its contents will be copied.

③ Whole Device

Copies all source data, bit-by-bit.

Scroll to select "Whole Device", then press "OK" to save the copy method.

Copies the whole source device, irrespective of content, format, partition, or empty space. This mode does not analyze the data.

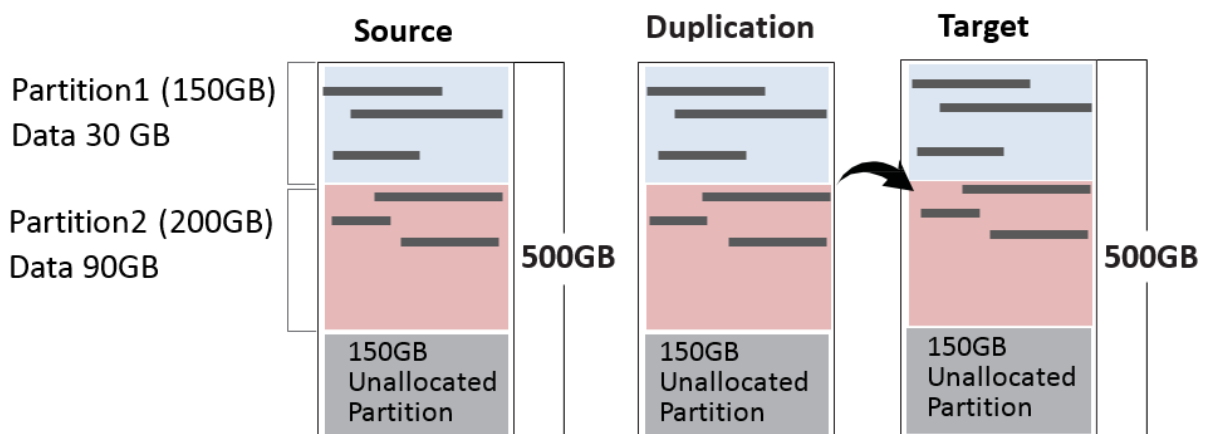

All 500GB of data will be copied.

④ Percentage (%)

Select percentage of source capacity to copy.

Scroll to select "Percentage", set the upper and lower %, then press "OK" to save the copy method.

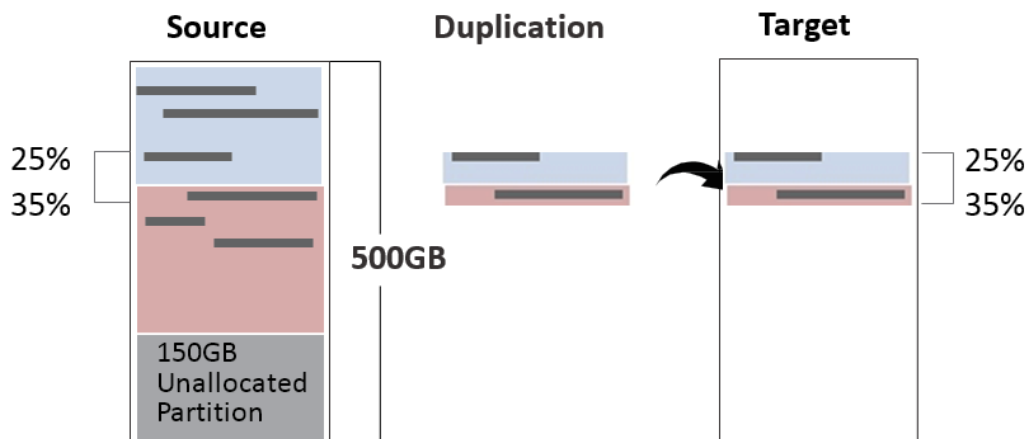

Only copies the selected area.

6.2 Copy GPT Backup Area

Disabling this function makes the duplicator ignore the GPT backup area, and thus allows the duplicator to copy from a big capacity device to a small capacity device(s).

Note The partition size of the source HDD should be smaller than target capacity. Otherwise, it is recommended to leave the GPT backup area intact.

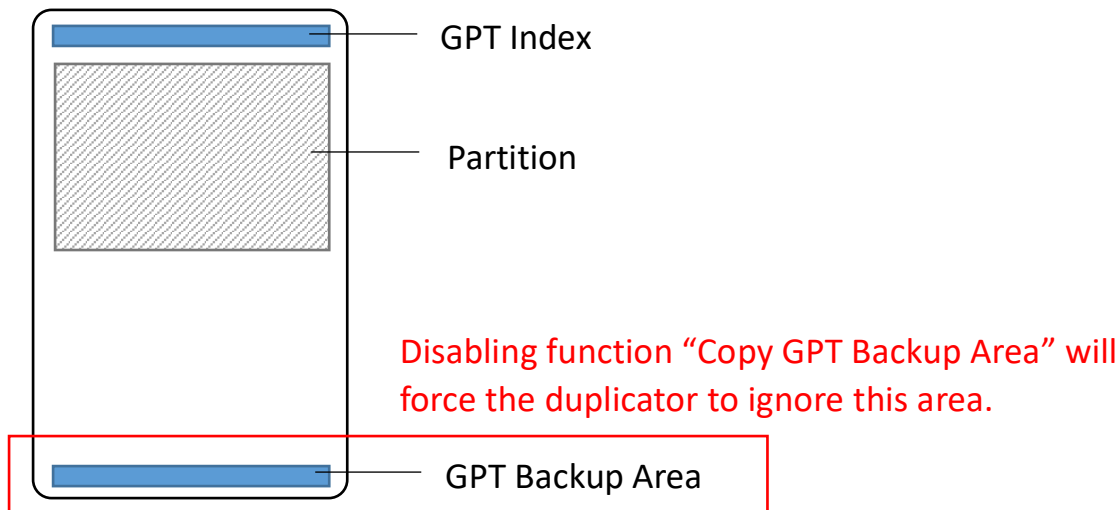

Caution GPT backup areas will be rebuilt automatically the next time Windows reboots. For Linux, tools such as gdisk can rebuild these backups.

6.3 HPA Copy Mode

This menu contains submenus related to HPA Copy Modes

Scroll to select "HPA Copy Mode", then press "OK" to view the submenus.

① Do Not Copy HPA

This menu contains submenu settings from which users can select.

Scroll to select "Copy HPA Area >> Do Not Copy HPA", then press "OK" view submenu settings.

● Keep Target HPA

Does not copy HPA data but keeps target device 's original HPA setting.

Scroll to select "Keep Target HPA", then press "OK" to save this setting.

● Clear Target HPA

Does not copy HPA data and clears target device's HPA setting.

Scroll to select "Clear Target HPA", then press "OK" to save this setting.

② Setting Target HPA

Copies HPA setting from source device to target.

Scroll to select "HPA Copy Modes >> Copy HPA Settings", then press "OK" to save this setting.

③ Copy and Setting

Copies HPA setting and data from source device to target.

Scroll to select "HPA Copy Modes >> Copy All HPA", then press "OK" to save this setting.

Caution HPA function "Copy and Setting" may change the original parameter of target devices. To reset it, user must set "Clear HPA at Erase >> Clear HPA Setting" and then execute "4. Erase."

6.4 Skip Bad Sectors

Scroll to select "Skip Bad Sectors", then press "OK" to scroll through the available values for skipping bad sectors. If the device data is critical and needs to be a full clone, it is recommended to set "Skip Bad Sectors" at "0." Bad sectors can be set as unlimited or at a value from 0 to 65,535.

Caution The "Copy+Compare" function is advised for enhanced copy accuracy.

6.5 Erase Source Port

This function allows user to enable or disable the source port for sanitization. Scroll to select "Erase Source Port", then press "OK." Then scroll through to select one of two settings.

① Disabled

Source port will be unable to erase.

Scroll to select "Erase Source Port >> Disabled", then press "OK" to save this setting.

② Enabled

Source port will be able to erase.

Scroll to select "Erase Source Port >> Enabled", then press "OK" to save this setting.

6.6 Unknown Format

This function only works with "Copy Mode >> System and Files."

Scroll to select "Unknown", then press "OK". Then scroll through to select one of two settings.

Unknown format includes all forms of modified and proprietary data and partitions.

① Copy Unknown

Copy unknown format(s).

Scroll to select "Unknown Format >> Copy Unknown", then press "OK" to save this setting.

② Skip Unknown

Skip unknown format(s).

Scroll to select "Unknown Format >> Skip Unknown", then press "OK" to save this setting.

6.7 Erase Pattern

Scroll to select "Erase Pattern", then press "OK". Then scroll through to select one of two settings.

① One Byte

Random character written per byte.

Scroll to select "Erase Pattern >> One Byte", then press "OK" to save this setting.

② Big Random Data

Random character written in a set of area.

Scroll to select "Erase Pattern >> Big Random Data", then press "OK" to save this setting.

6.8 Clear HPA at Erase

Sets to clear HPA setting during erase.

Scroll to select "Clear HPA at Erase", then press "OK" to save this setting.

① Clear HPA Setting

Clears HPA setting and data during erase.

Scroll to select "Clear HPA at Erase >> Clear HPA Setting", then press "OK" to save this setting.

② Keep HPA Setting

Keeps original HPA setting and data during erase.

Scroll to select "Clear HPA at Erase >> Keep HPA Setting", then press "OK" to save this setting.

6.9 Language

Select English, Japanese, Spanish.

Scroll to select "Language", then press "OK." Then scroll through select the desired language.

6.10 Target Tolerance

This function sets the capacities tolerance range between the source and target device. If the capacity is outside the tolerance range, the copy will fail.

6.11 Clean SSD Before Copy

Sets to clear SSD before copy function. The default setting is "No".

6.12 Restore Defaults

Restores all setting to manufacture defaults.

Scroll to select "Restore Defaults", then press "OK" to restore settings back to manufacturer defaults.

Maintenance Guide

Steps to replace M.2 socket(s)

- 1 Turn off power

Caution

For your safety, please turn off the power before inspecting or replacing the socket.



- 2 Remove the faceplate screws.



Caution

Please use extreme caution while using a screwdriver to remove the screws as it can easily slip and damage the surrounding area.

3 Remove the cover plate.

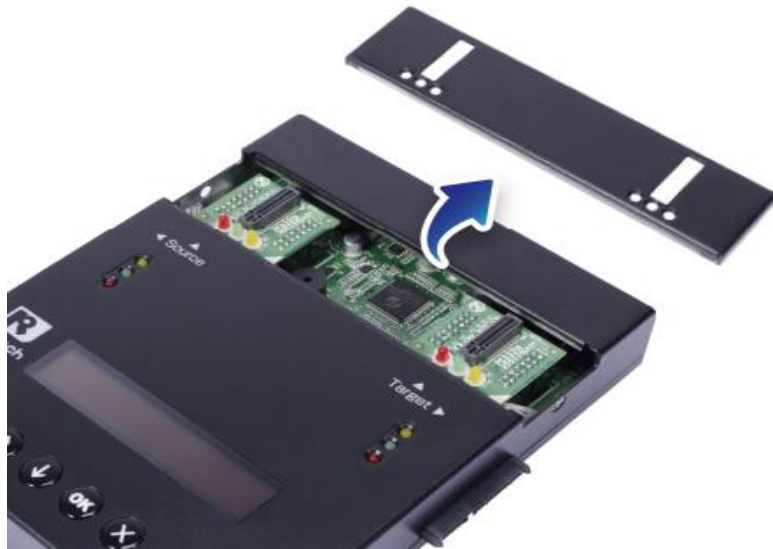

4 Replace the socket(s).



5 Replace and secure the cover plate.

